

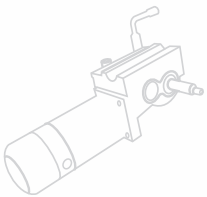

ROTOMAJ
water energy motion

AFFORDABLE MOTOR AND DRIVE SOLUTIONS FOR

FLOOR CARE

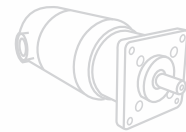
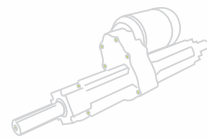
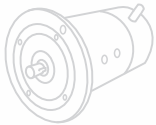
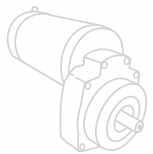

MOTORS FOR FLOORCARE

Brush Motors with Helical Gears



ROTO M J G
water energy motion

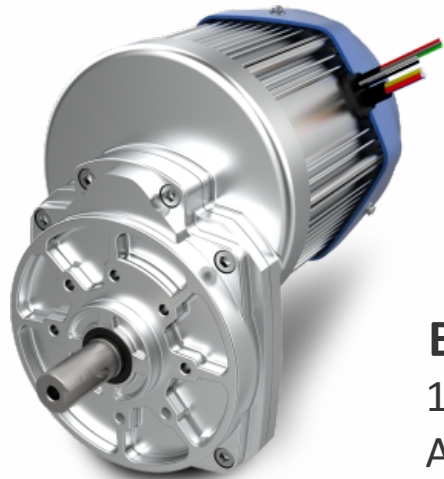

BLDC Motor
1KW-24V-150RPM
Available ratio 10

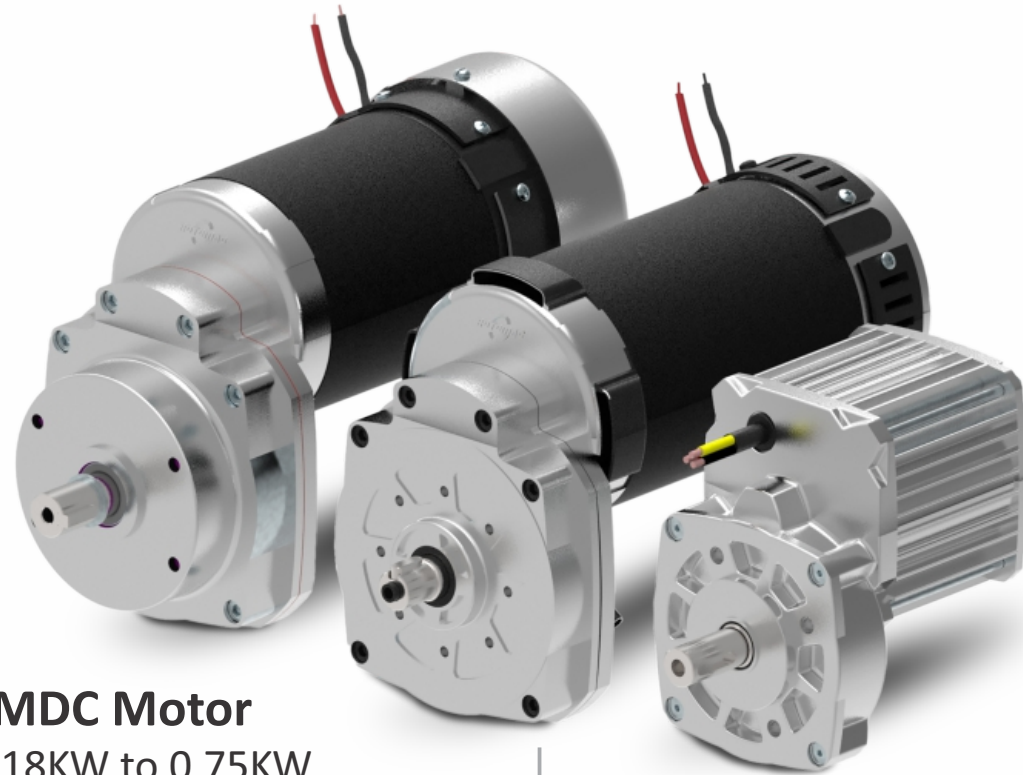

PMDC Motor
0.18KW to 0.75KW
Available ratio 1:10, 1:7,
IP 20/IP44 option, internal or
external fan cooling

BLDC Motor
0.5KW-24V
Available ratio 9.6

Options: Different gear ratios, motor speeds, with brakes, mounting as per customer request

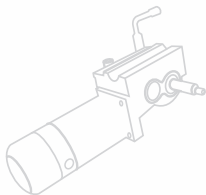
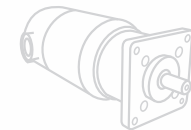
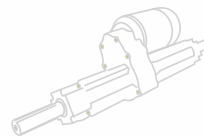
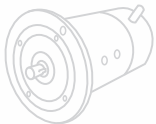
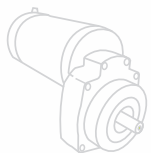

MOTORS FOR FLOORCARE

Brush Motors with Worm Gears



ROTOJG
water energy motion

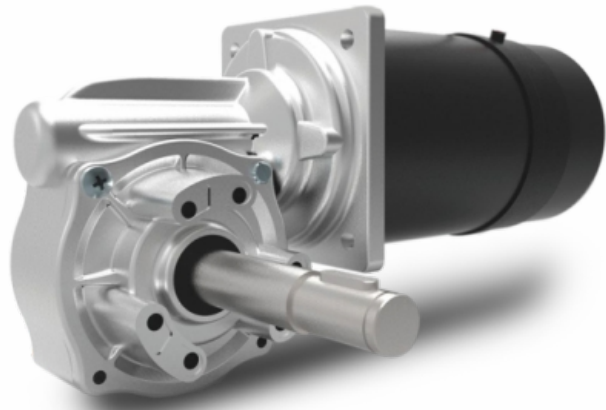

PMDC Motor

0.15KW to 0.26KW
Available ratio 1:18

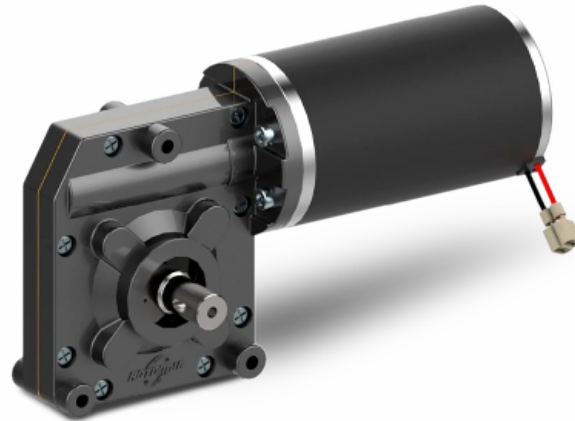

PMDC Motor

0.1KW to 0.2KW

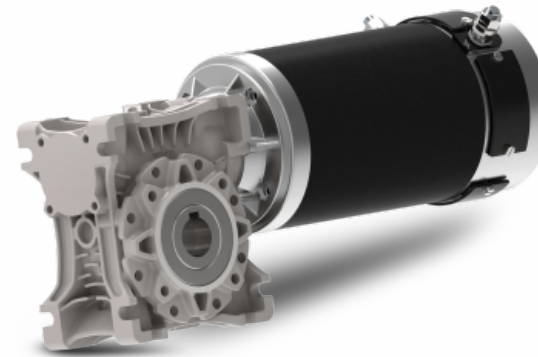

PMDC Motor

0.18KW to 0.75KW
Available ratio
7.5,10,...100

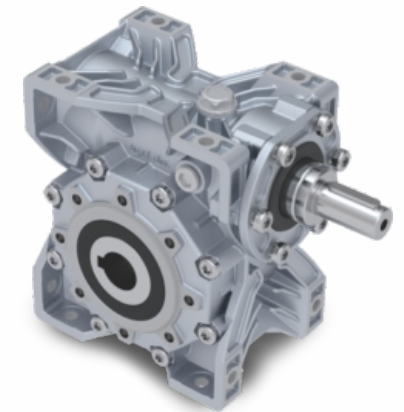

Worm Gearboxes

Available from
Size 30 to 150

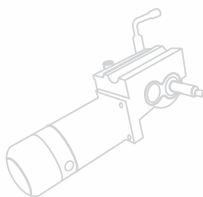
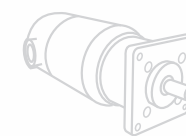
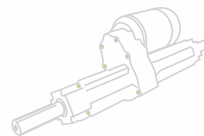
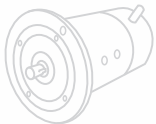
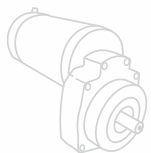

MOTORS FOR FLOORCARE

Traction Motors/ Transaxle



ROTO M J G
water energy motion

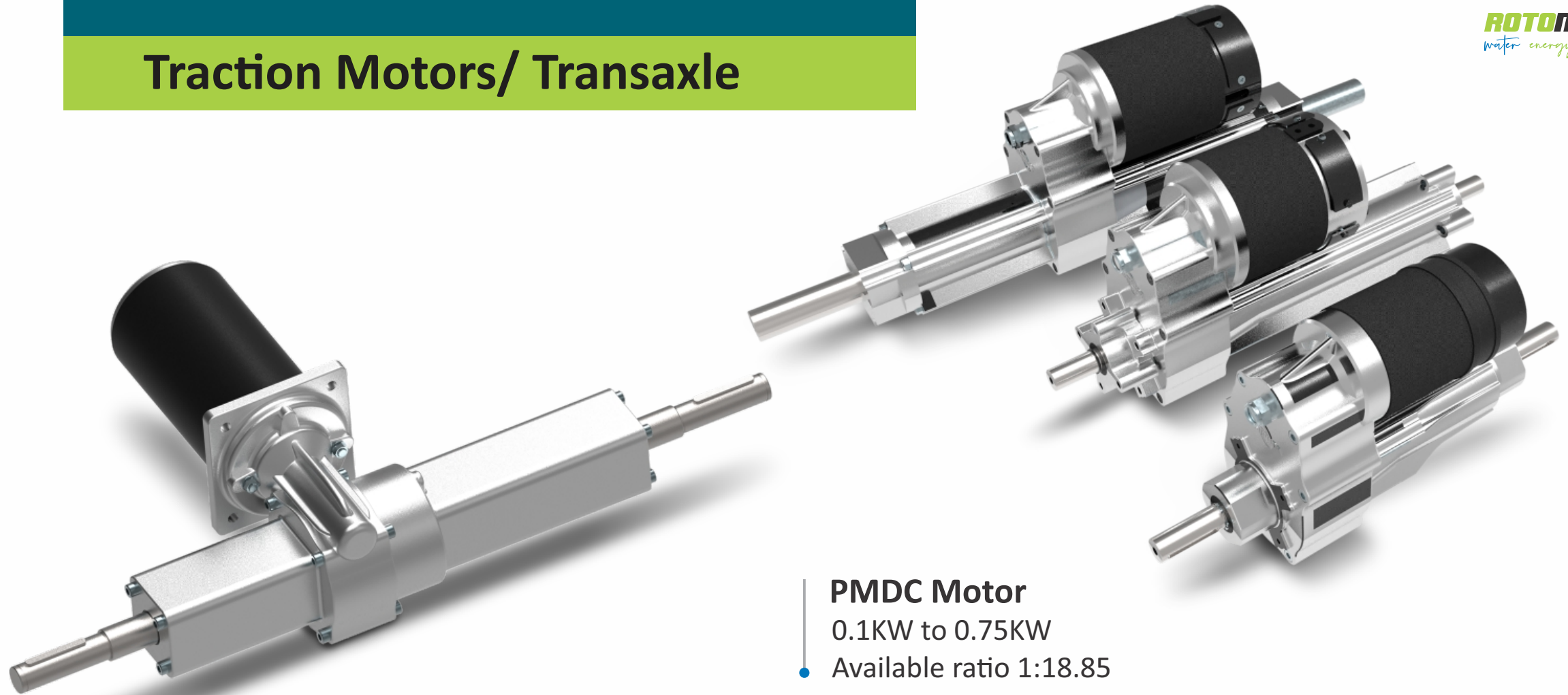

PMDC Motor
0.1KW to 0.75KW
• Available ratio 1:18.85

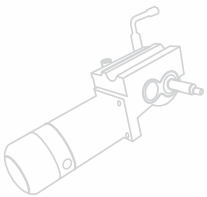
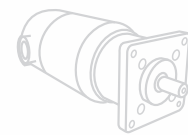
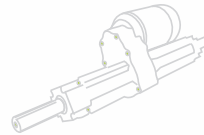
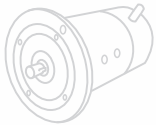
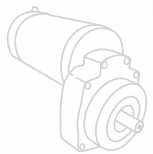

MOTORS FOR FLOORCARE

Brush Motor - Ung geared



ROTO M J G
water energy motion

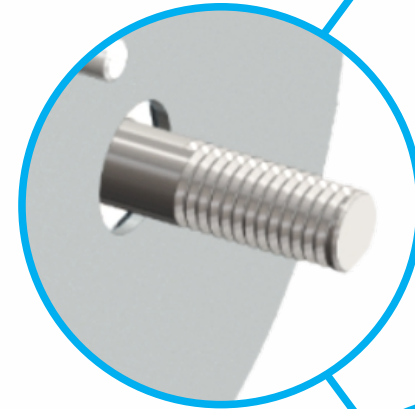

Option available
for Different Design
of Shaft & Flanges

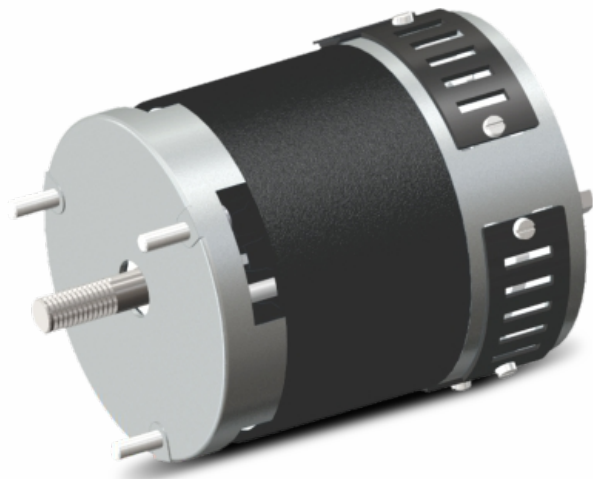
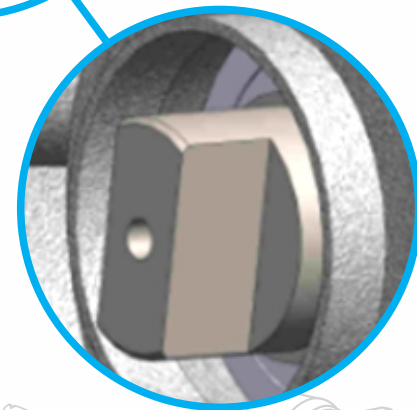

PMDc Motor
0.08KW to 0.75KW



Shunt Wound Motor
0.75KW to 2.2KW

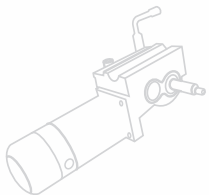
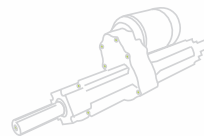
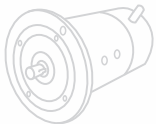
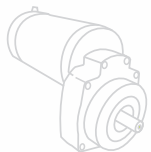

MOTORS FOR FLOORCARE

Brush Motor - Ungearred

- Customized Shaft
- Flanges
- Power
- Enclosure



ROTO M J G
water energy motion



ROTOMAG

DC MOTORS FOR
INDUSTRIAL APPLICATIONS

www.rotomag.com

rotomotive
looks good. performs better.

AC MOTORS AND
GEARBOXES

www.rotomotive.com

ROTOMAG
Water from the Sun

SURFACE & SUBMERSIBLE
SOLAR PUMPS

www.rotosol.solar

 **CYCLO**

PLANETARY & CYCLODIAL
GEARBOXES

www.cyplagear.com



ROTOMAG MOTORS & CONTROLS PVT LTD

2102/03 & 04, GIDC, Vitthal Udhyognagar,
Near Anand - 388121, Gujarat, India

Phone : +91 92746 84894 / +91 93771 73406

Email : sales@rotomag.com

Web : www.rotomag.com